



RAM MkII Kangaroo

HDM35131

+39 06 39736835
info@hdmodels.it
www.hdmodels.it

1/35



Credits
Master - Fabio Sacchi
Artwork - Bill Mill
3D - Gabriele Fioroni

Resin scale model. This is not a toy. Kit is not recommended for children under 14 years of age.

The kit contains resin parts and can only be used by experienced modelers. The kit needs assembly and painting and comes in separate pieces.

Applying tools and glue suitable for mounting resin parts.

Epoxy or cyanoacrylate is recommended. Working in ventilated spaces.

Beware the kit contains very small pieces that could be swallowed by children.

OLD GARAGE

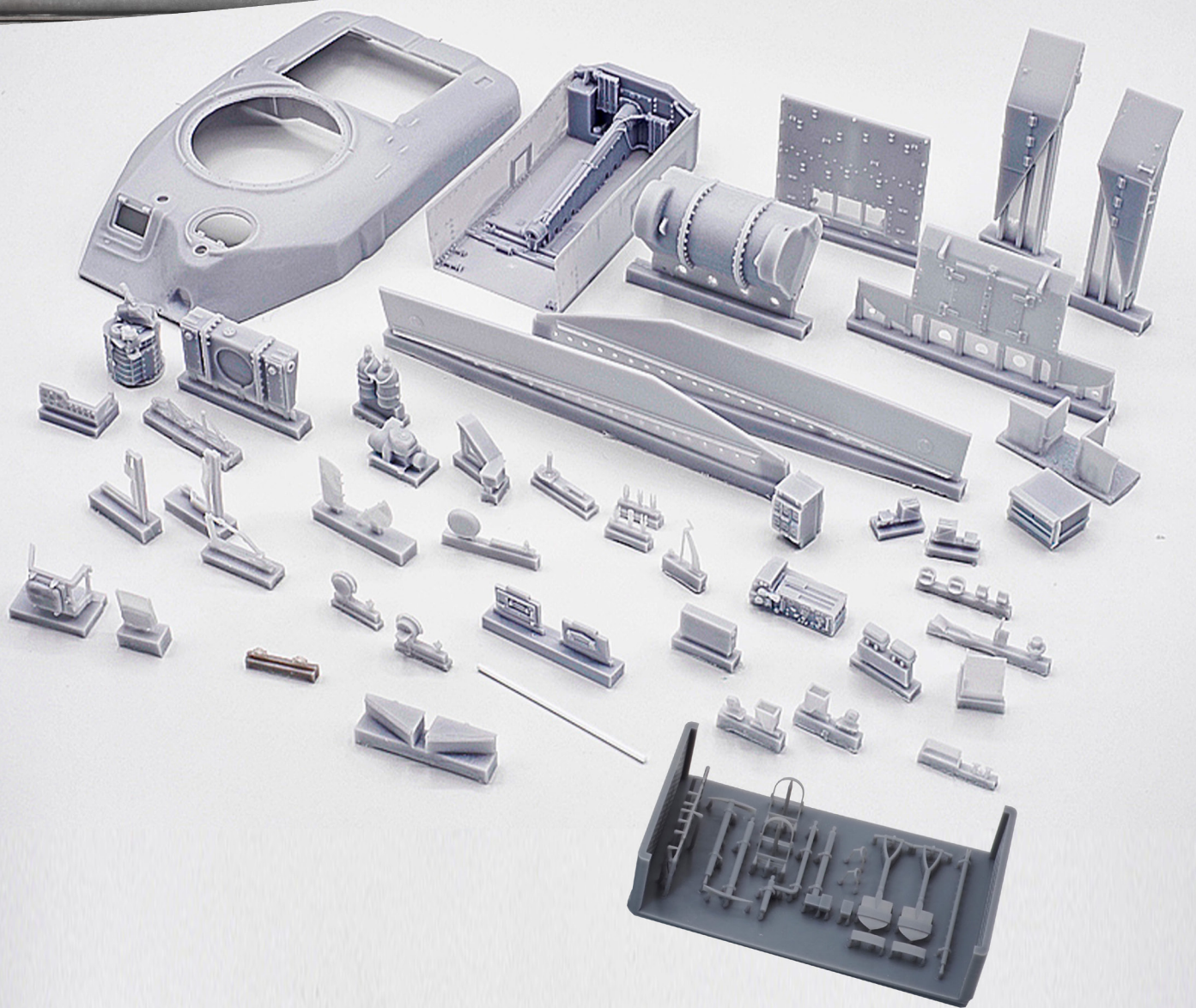

HDM35131 RAM Mk II late "Kangaroo" 1/35

Artwork created by Bill Miller, 1st Canadian Armoured Carrier Regiment Archive.
Calgary, AB Canada. telephone 403-605-0059 email: info@canadiakangaroos.ca

157

157

157



CT-15 9891
CT-160098
CT16 0122

BUTCH
BUTCH
MARION FAME
MARION FAME

Dear Modeller. Thank you for having purchased a very limited run, multi media kit. We tried our best to ensure you will get a great kit and that you will enjoy it.

Work with resin parts



This kit has enhanced details by using 3d technology printed parts. To ensure a flawless removal of these parts from runners :

- 1) heat the resin parts with the hair dryer at a distance of 20cm for about 10 seconds
- 2) use our steel cut tweezers to remove or use a sharp blade

1) CUT FLUSH LOW HULL

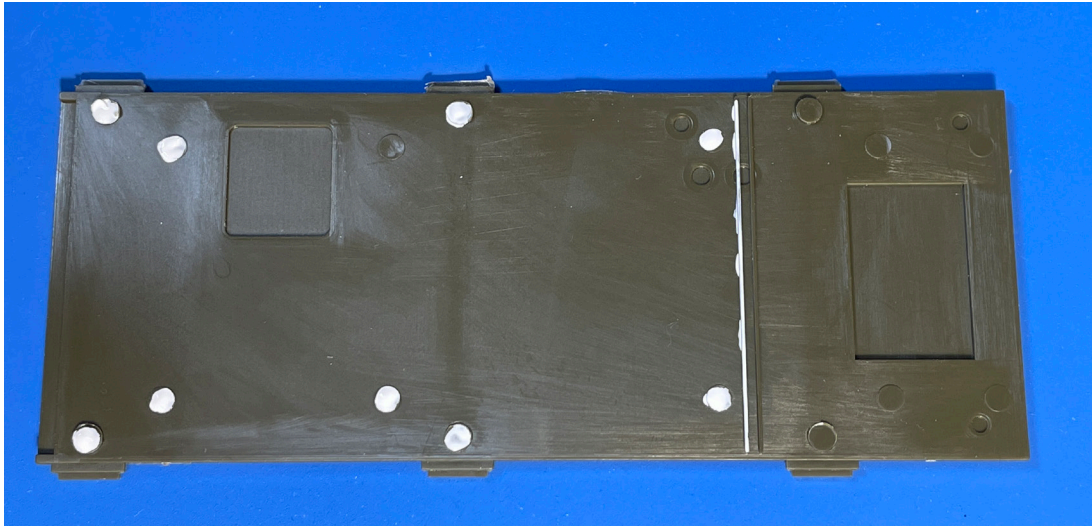

2) CUT FLUSH SIDE HULLS

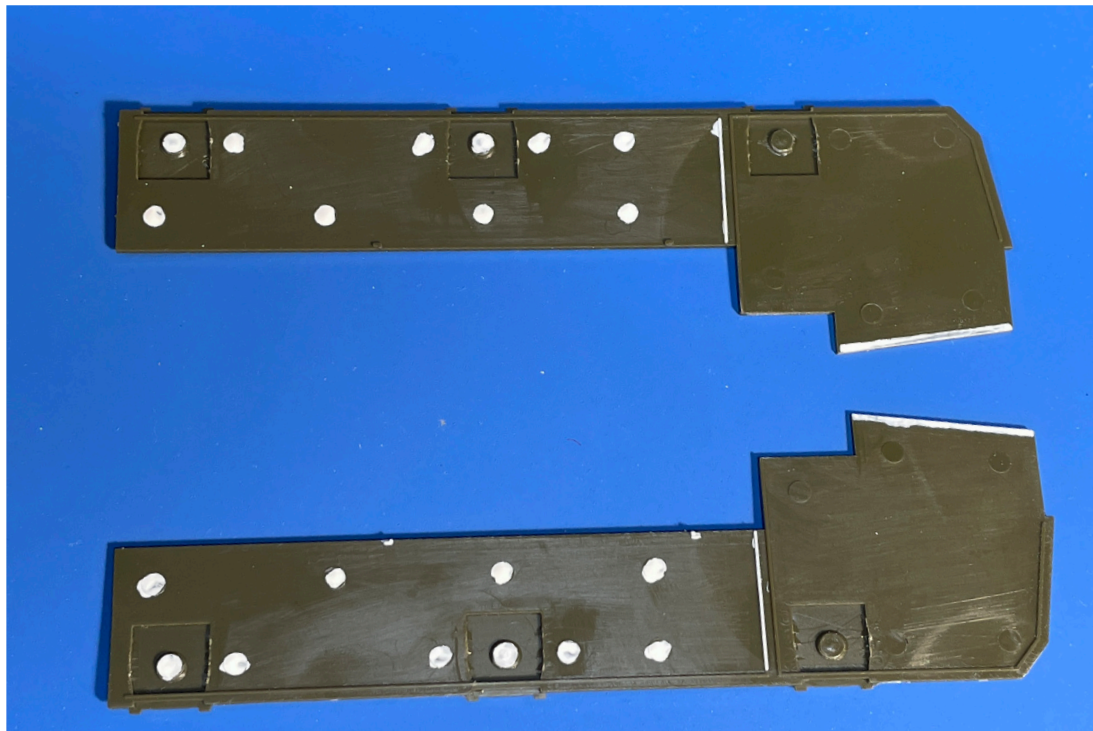

3) ASSEMBLE PARTS

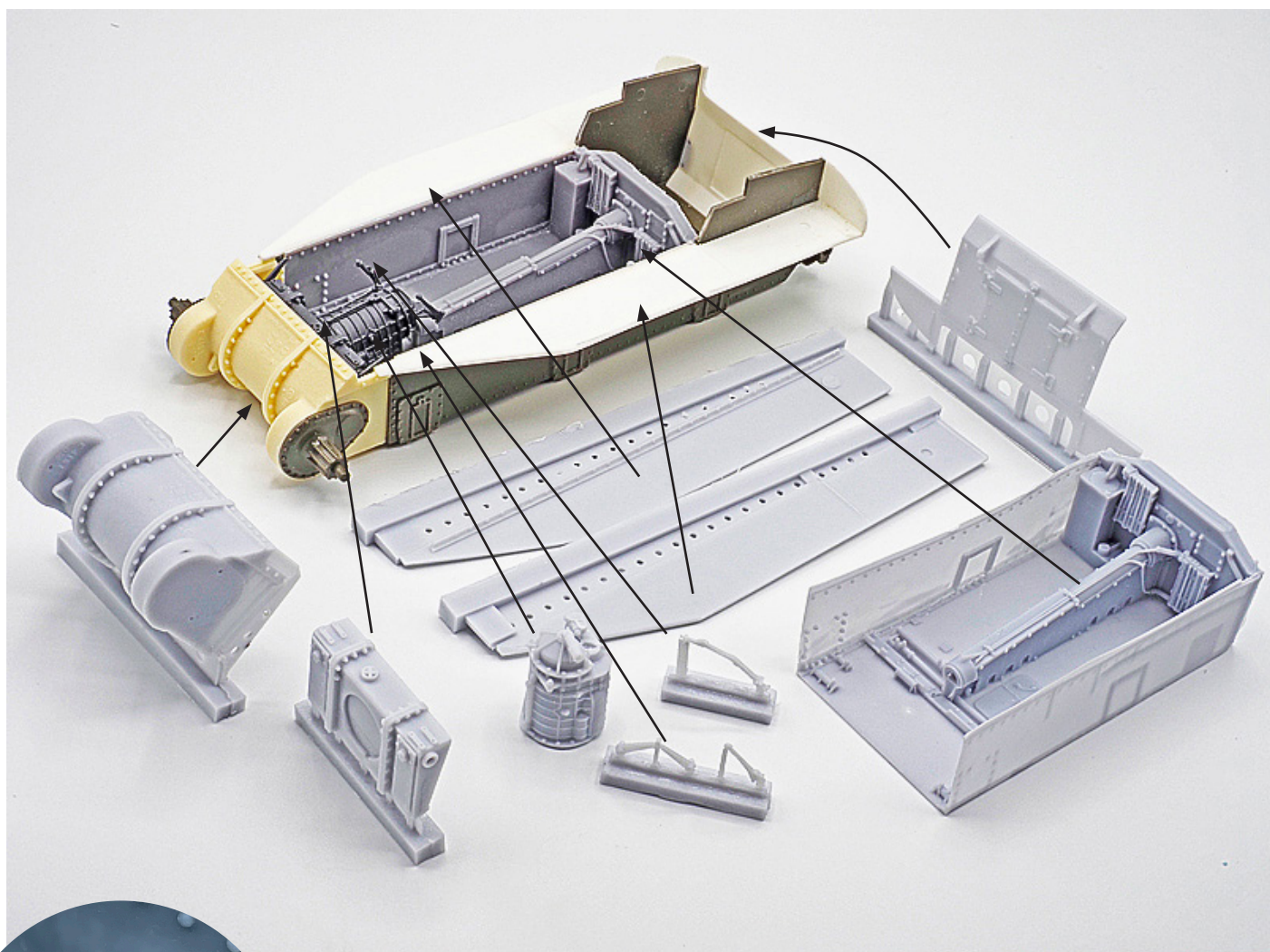

MAKE 0,3 ROD WIRE AT "U" SHAPED

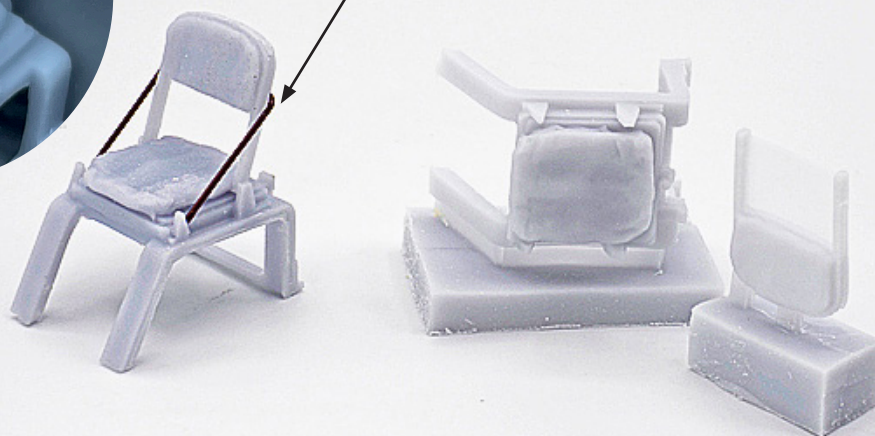

5) INTERIOR HULL

if you want more details you can add lead wire

GLUE PARTS

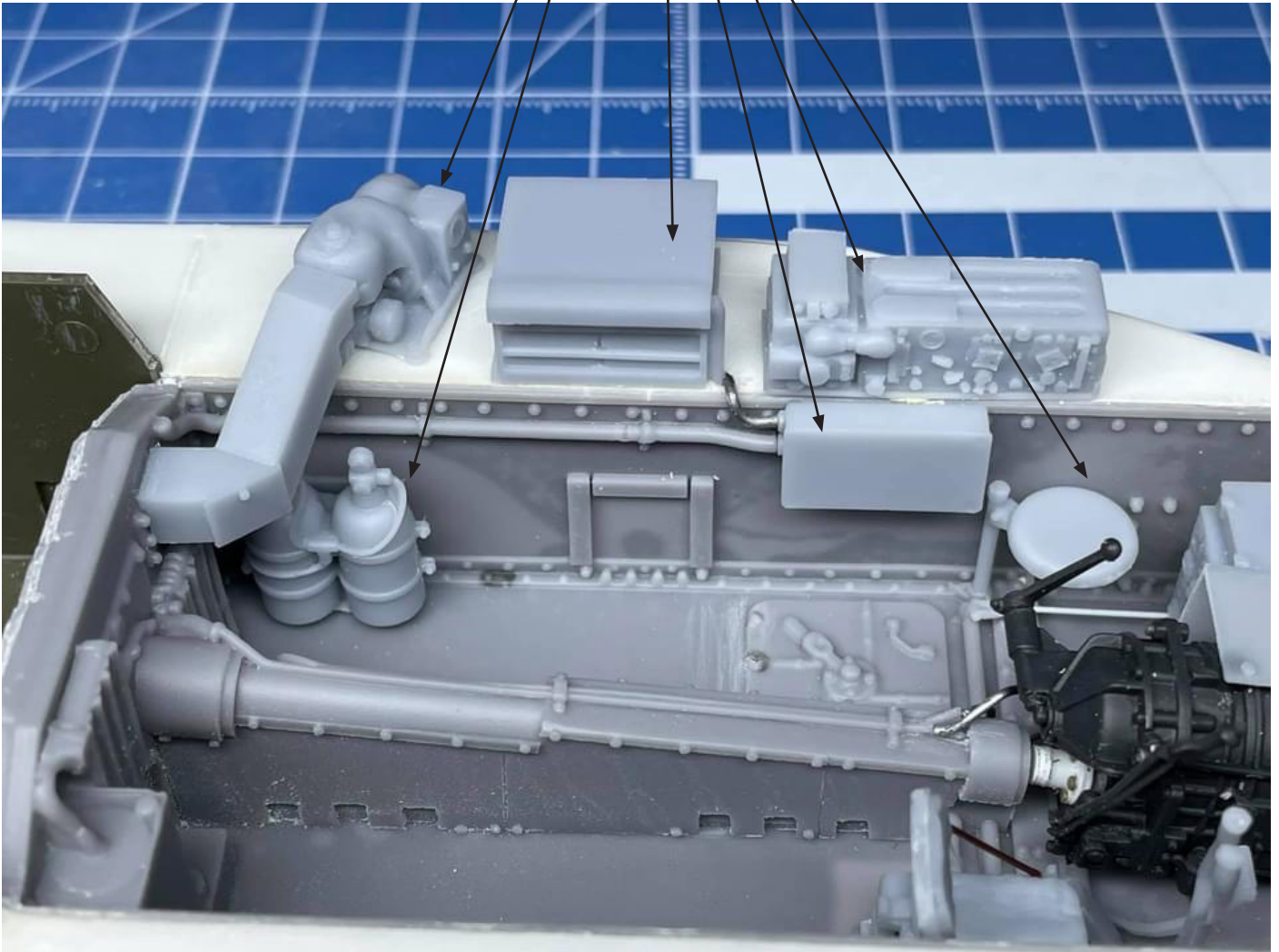

GLUE PARTS

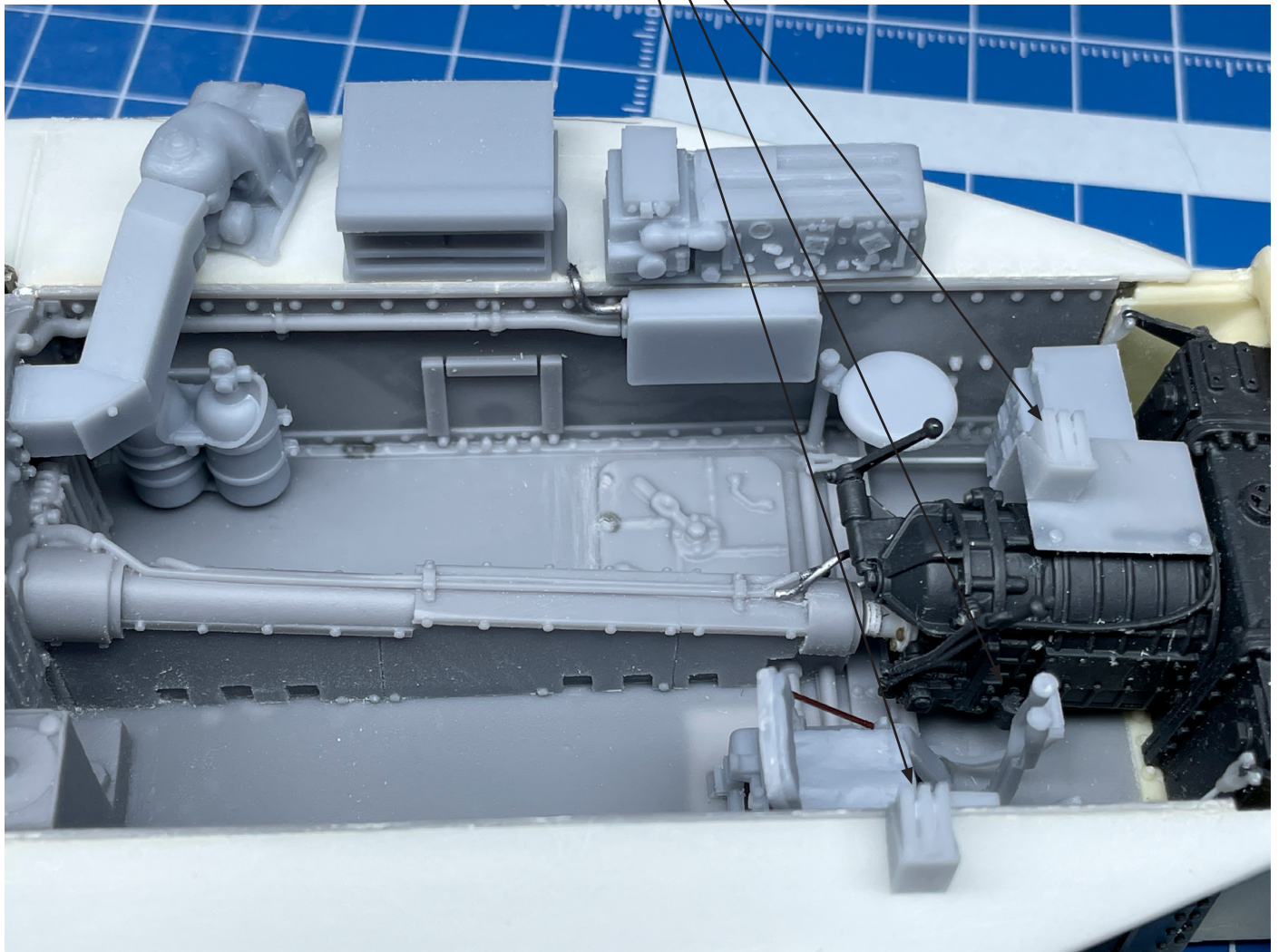

7) INTERIOR HULL - DRIVER SIDE VIEW

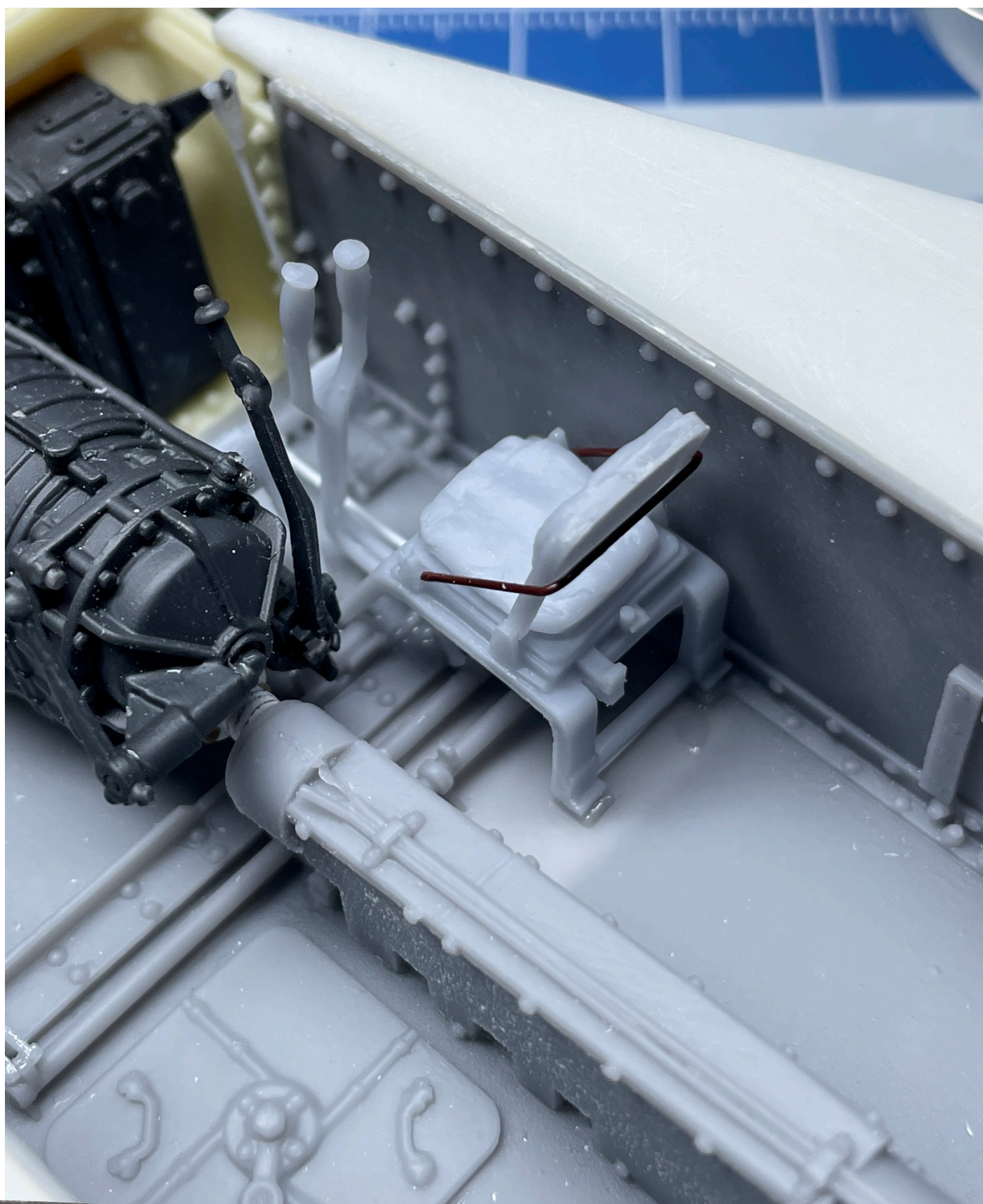

If you want more details you can add steering levers using resin caps and 0,3 rod or stretched sprue



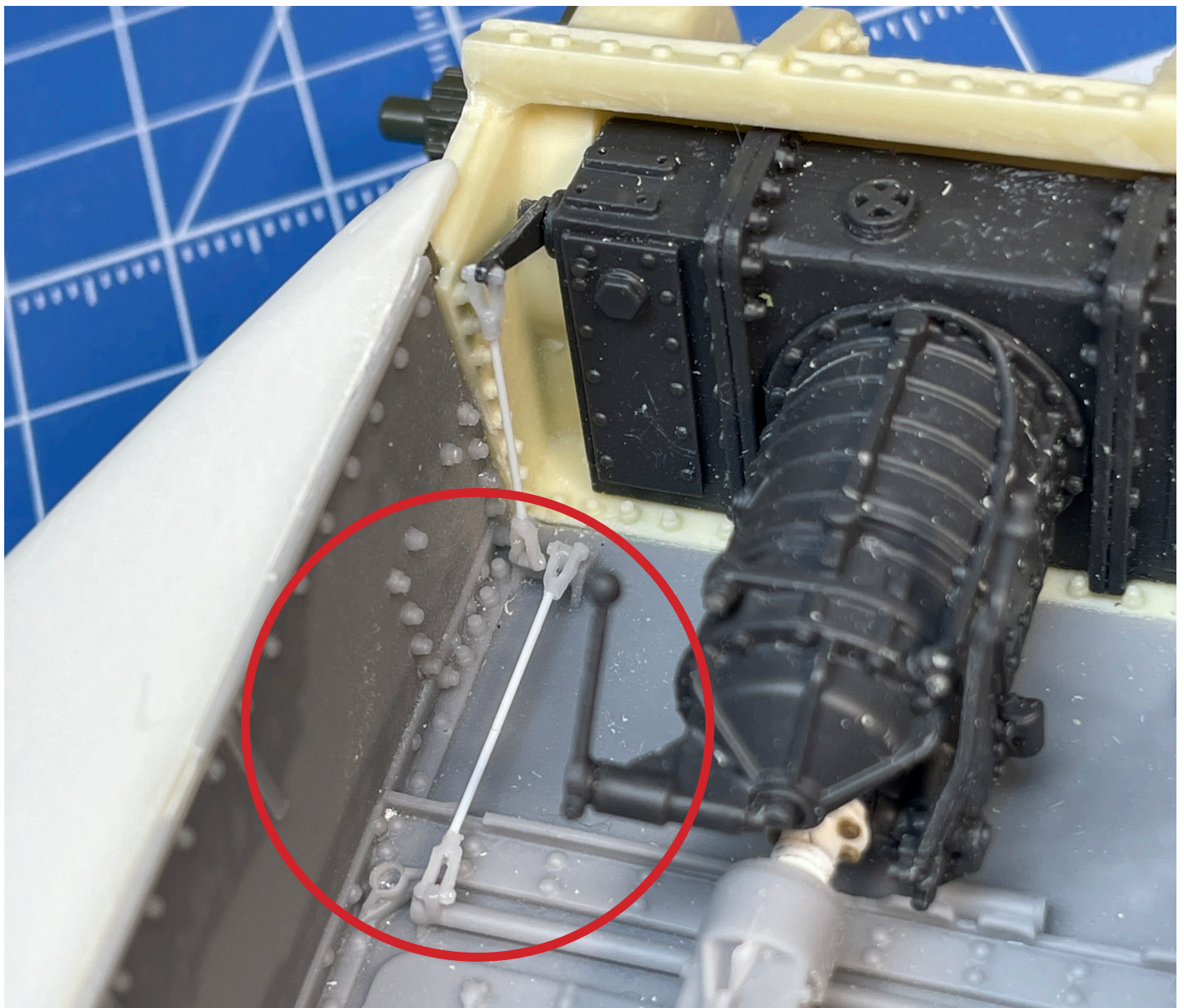

STEERING LEVERS

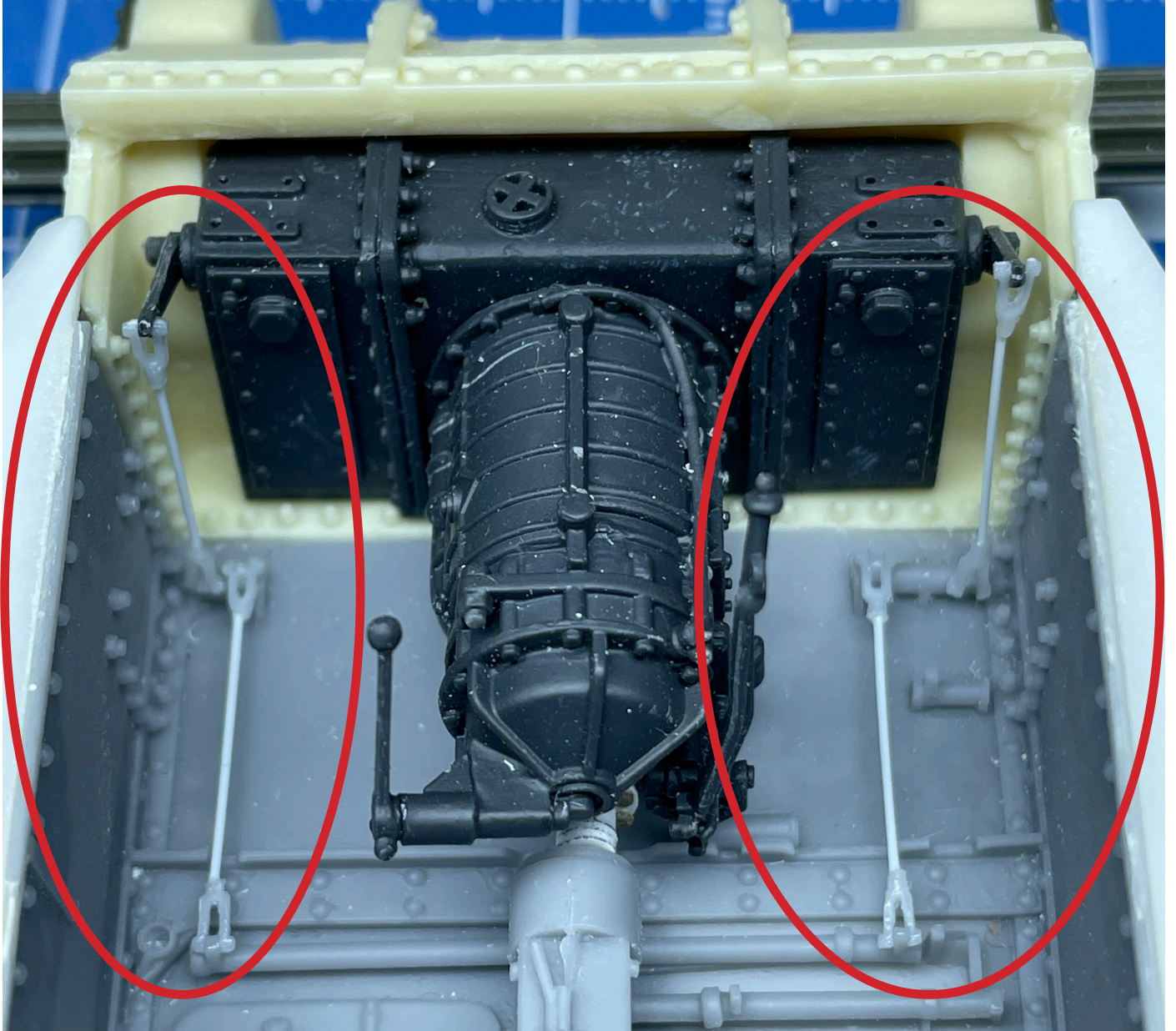

STEERING LEVERS

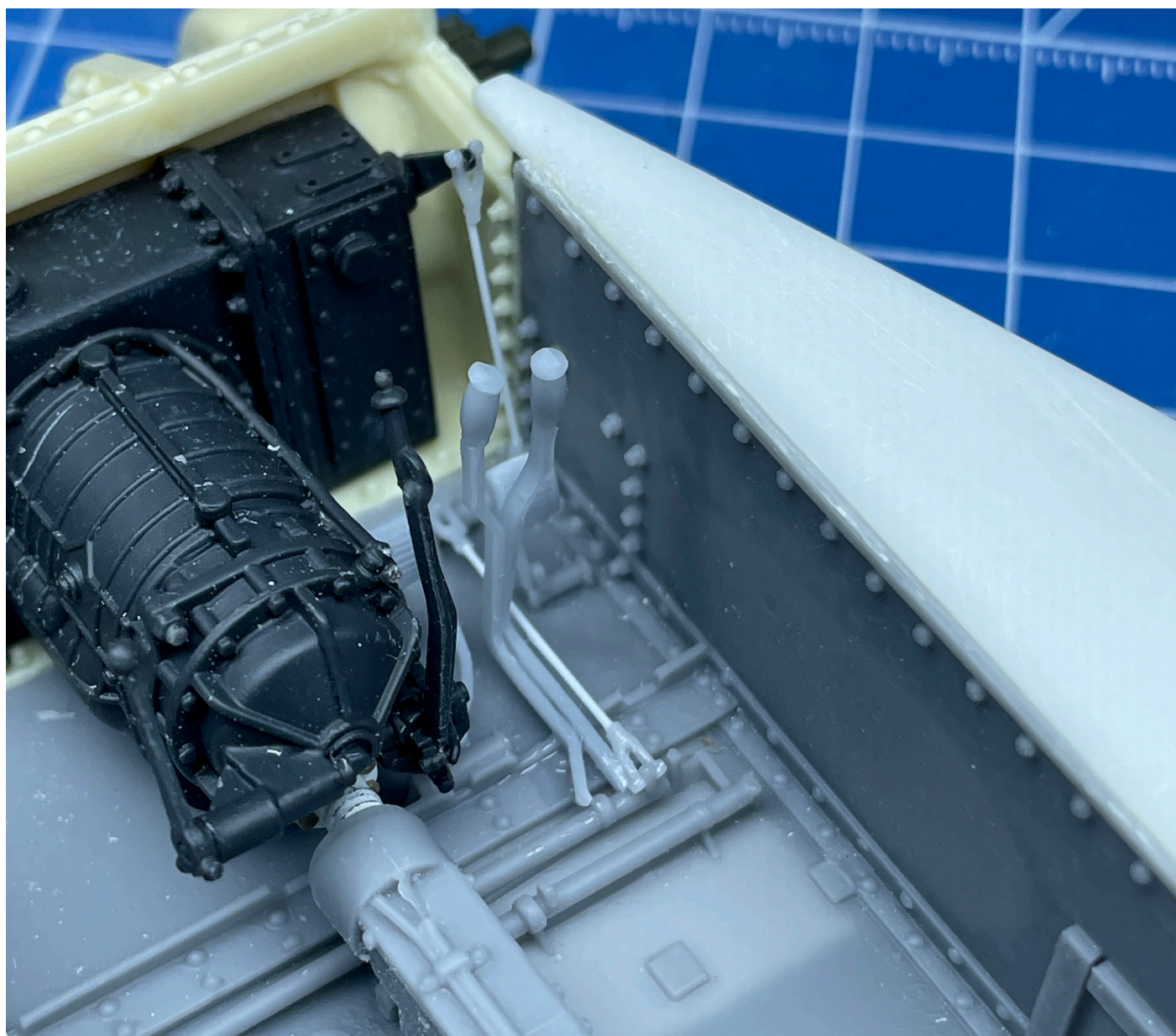

VIEW OF STEERING LEVERS WITH
COMAND DRIVE LEVERS

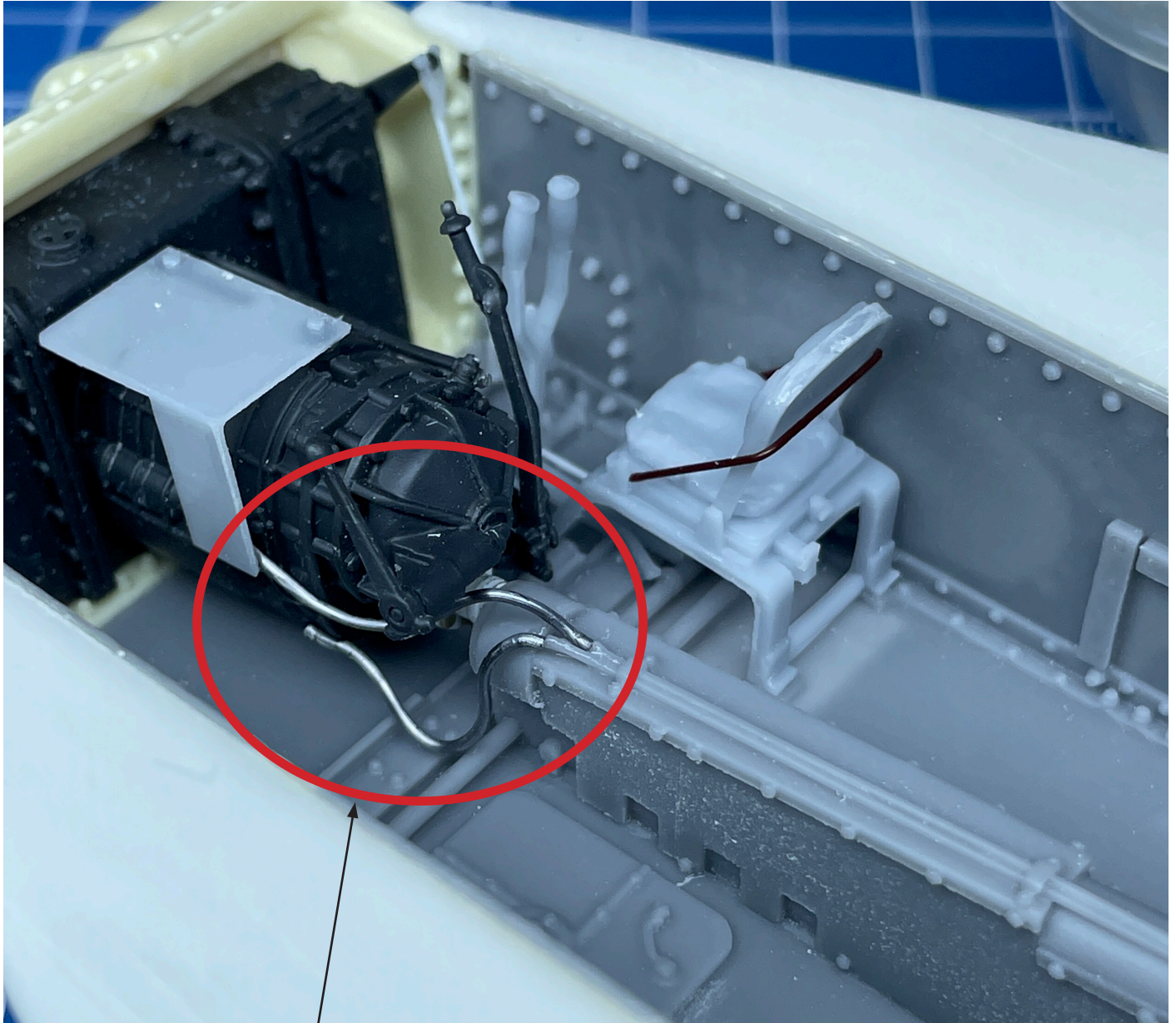

ADD LEAD WIRE

TAKE UPPER HULL RESIN PART AND TURN IT OVER AND GO TO THE BACK.
THEN GLUE PLASTIC PARTS AND ADD COVER RESIN PARTS

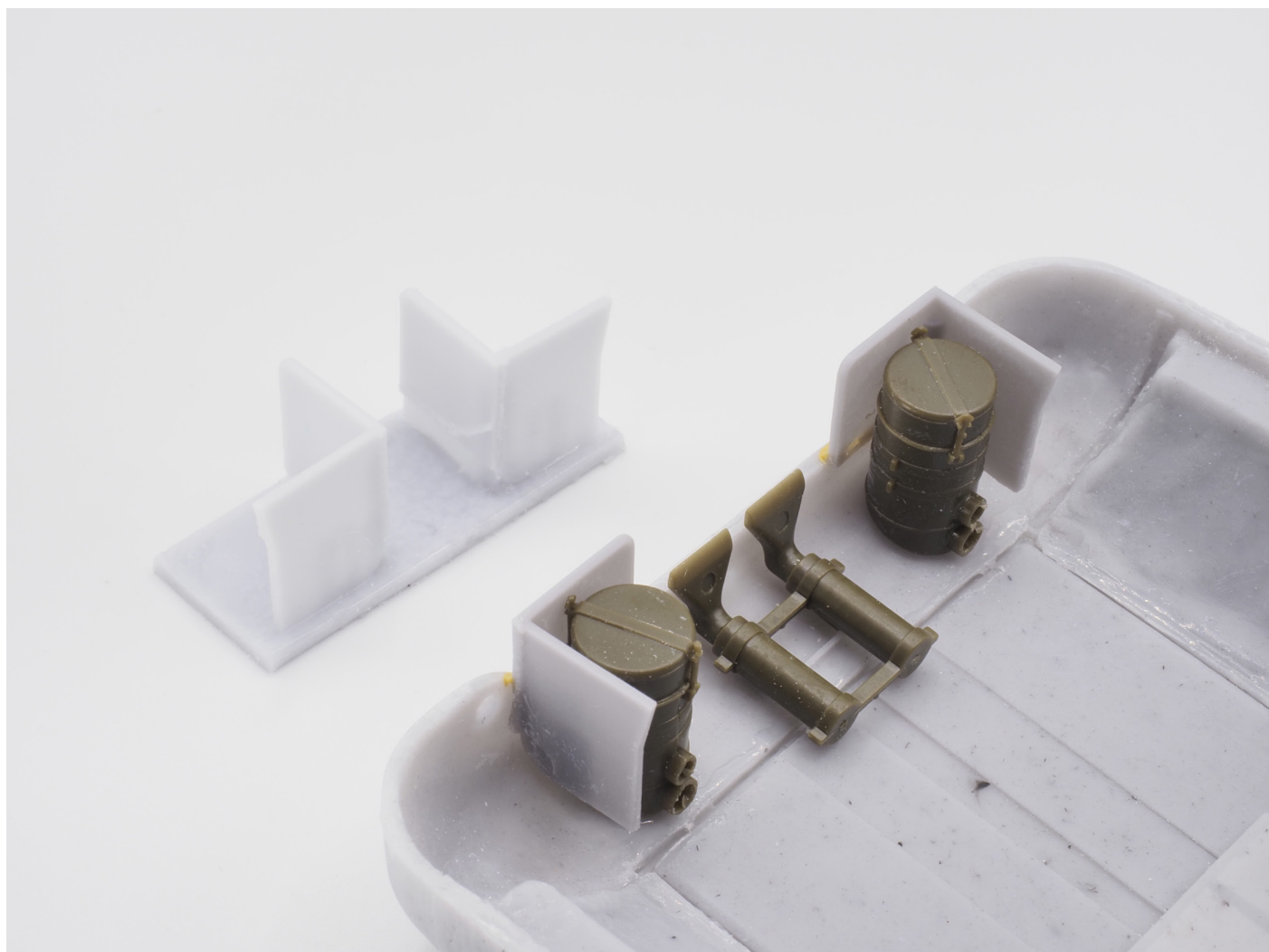

TURN THE HULL AGAIN AND THEN GLUE PLASTIC PARTS AND ADD RESIN PARTS

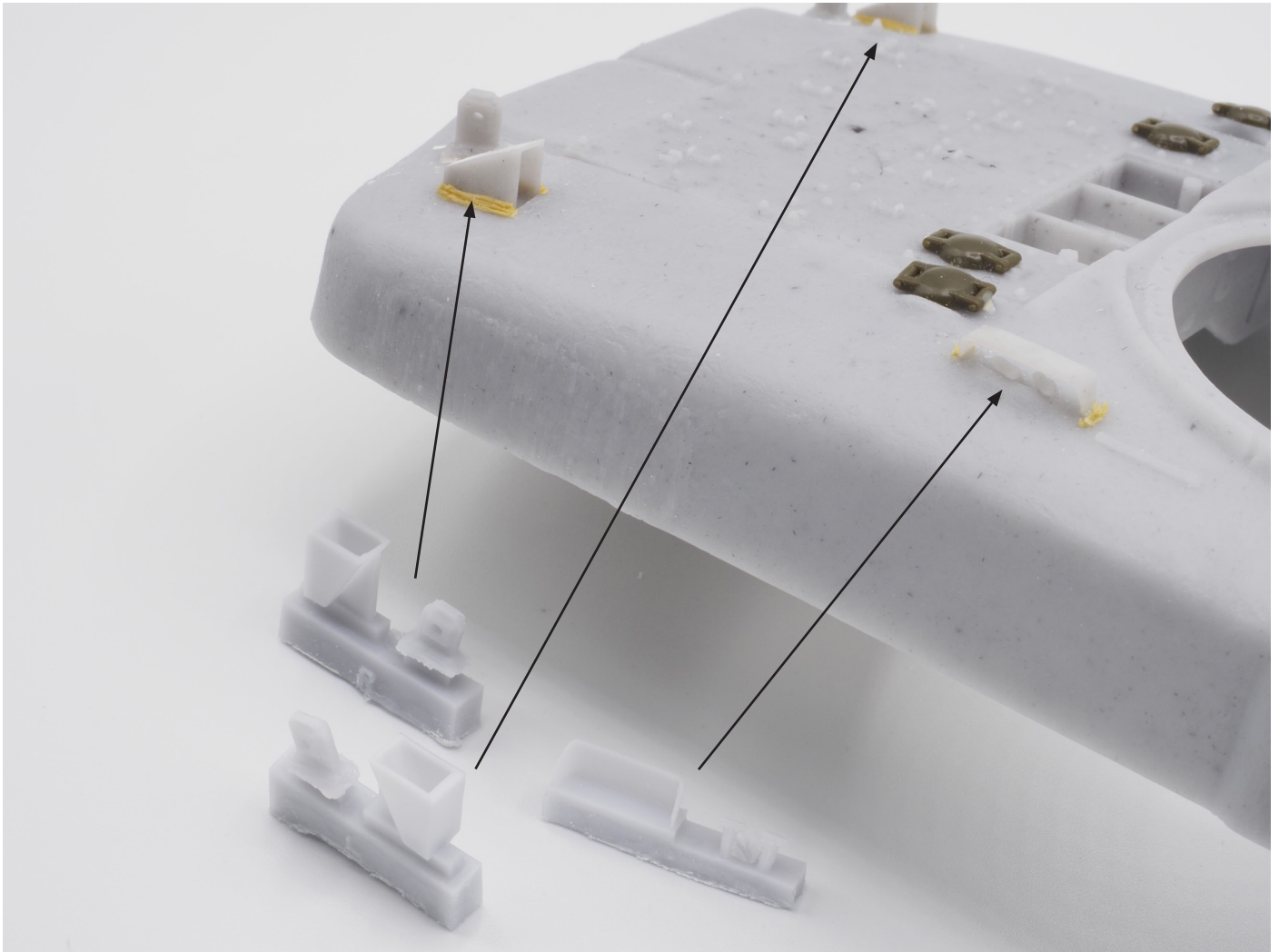

GLUE RESIN PARTS AND ADD MINISTRIP

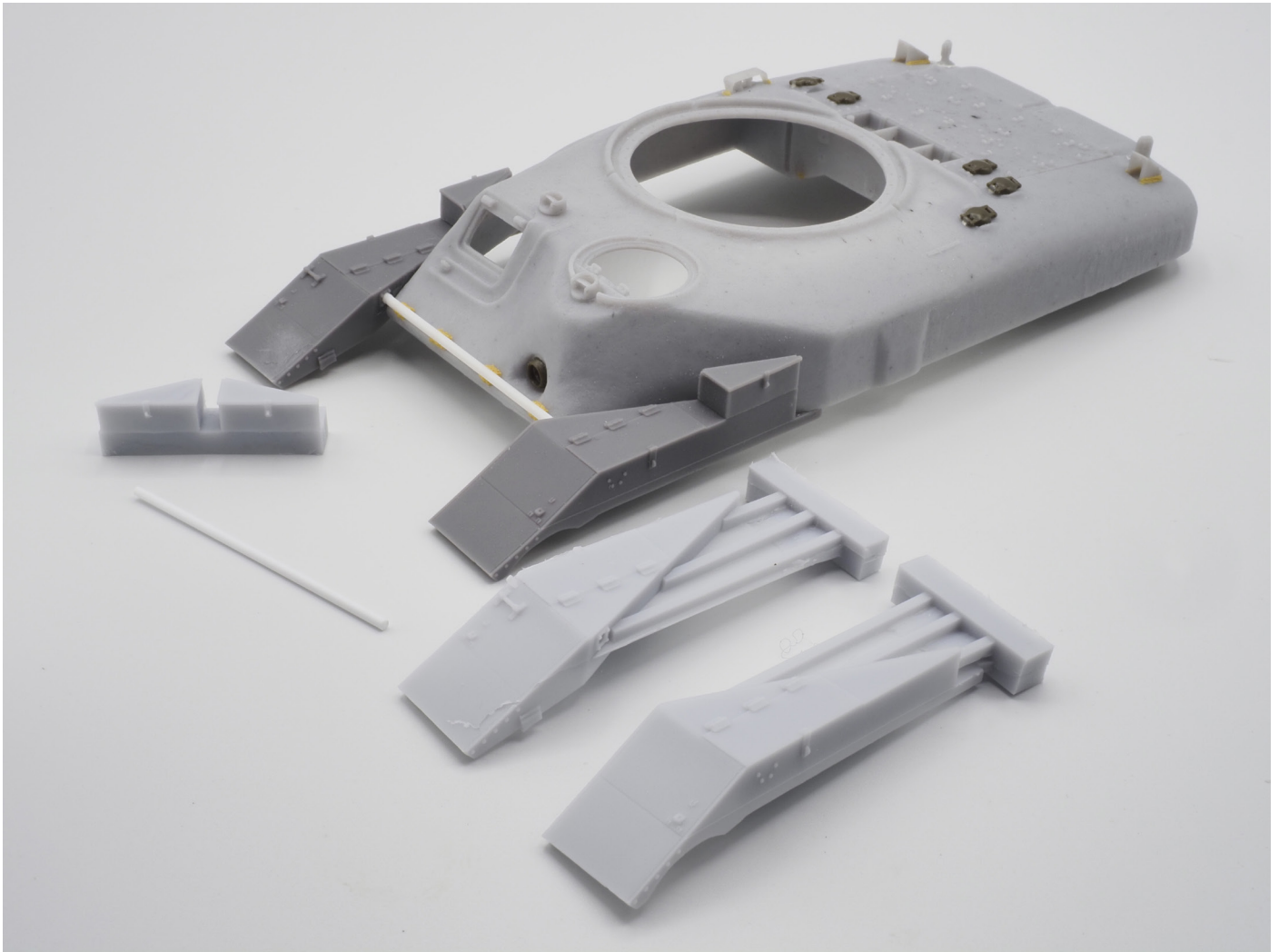

FINAL VIEW OF BOTH HULLS

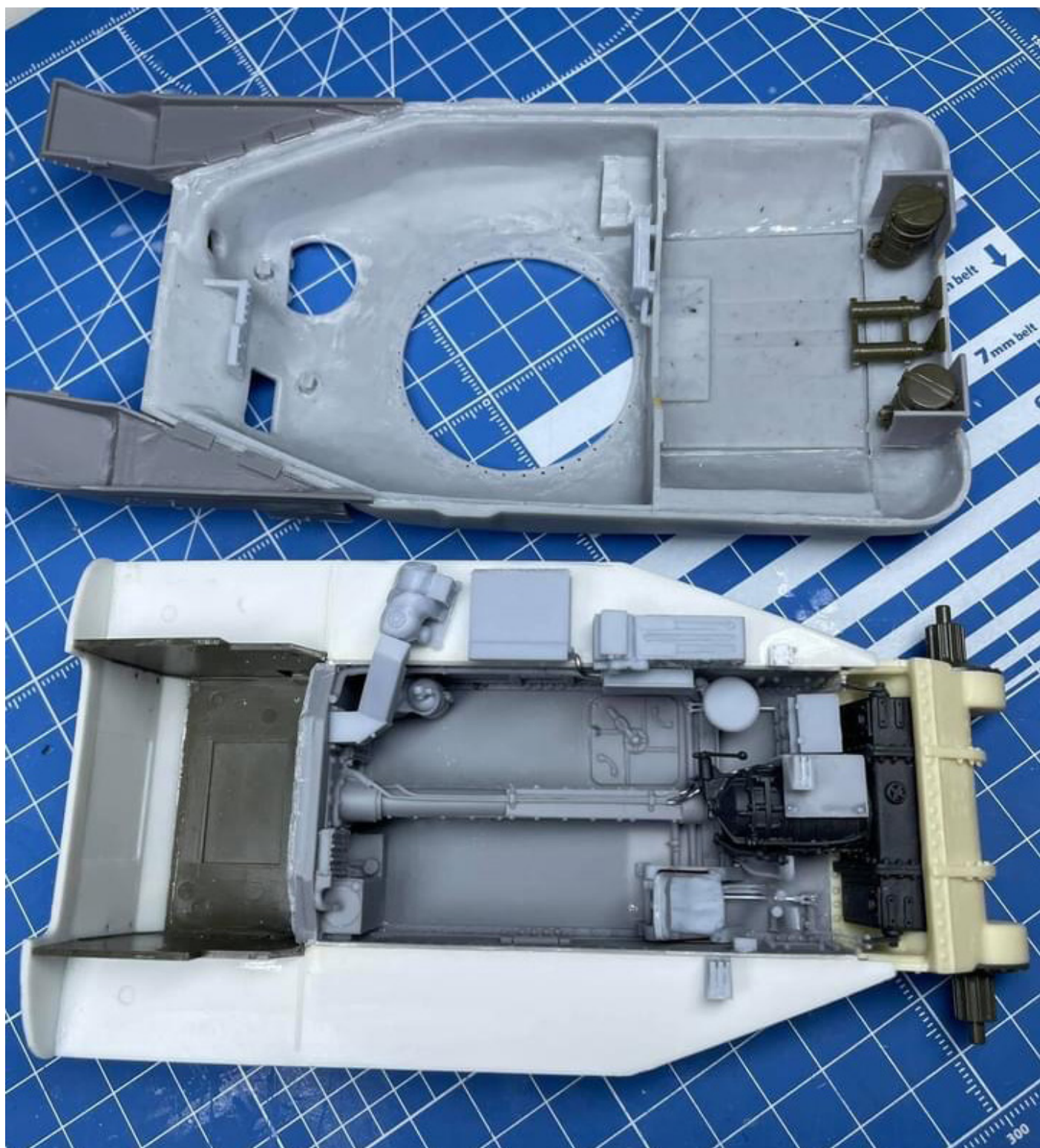

11) OVM TOOLS AND 3D PARTS

GLUE NET (3D PART)

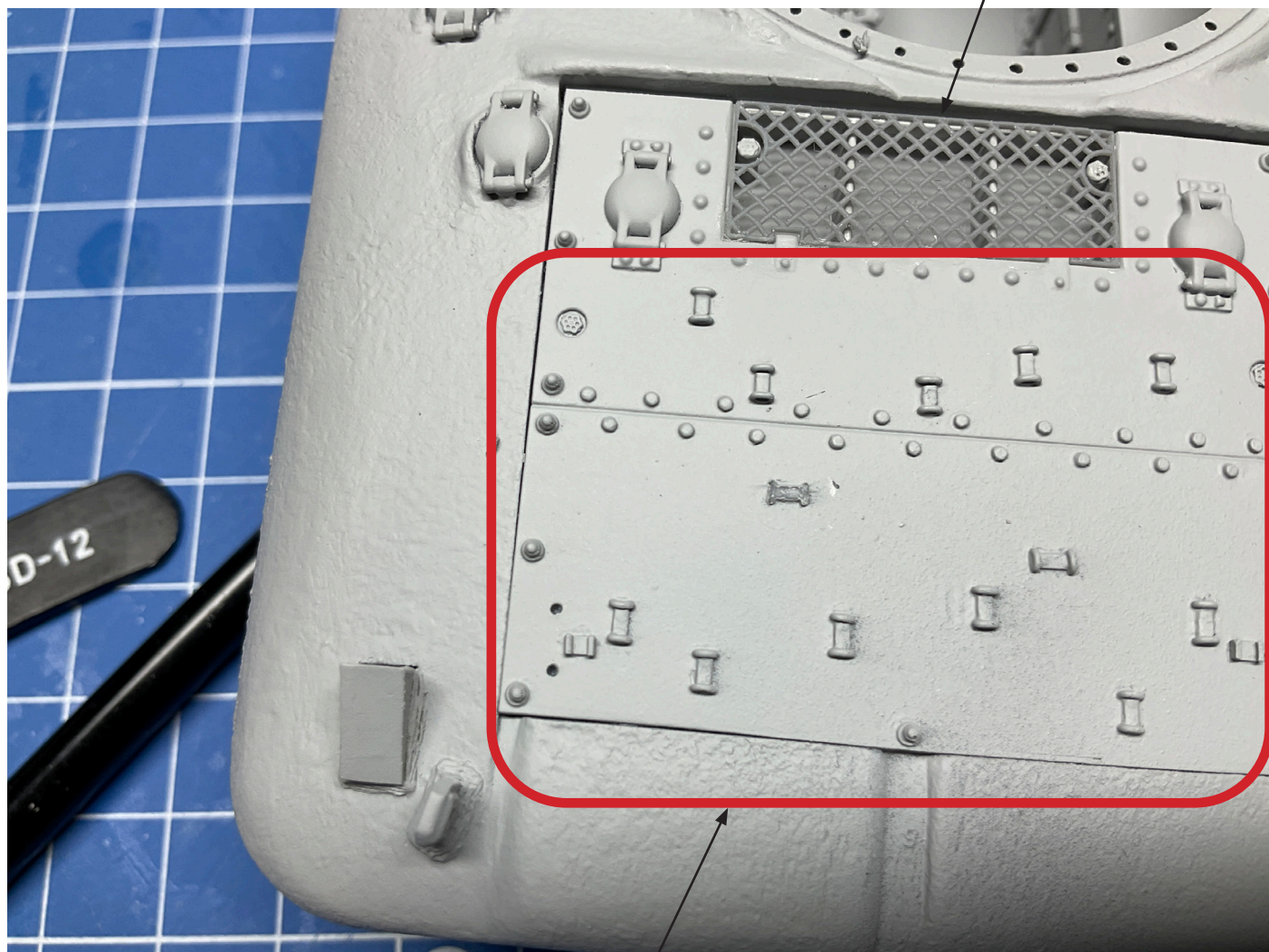

IF YOU DON'T INSTALL OVM TOOLS LEAVE AS IT THIS.

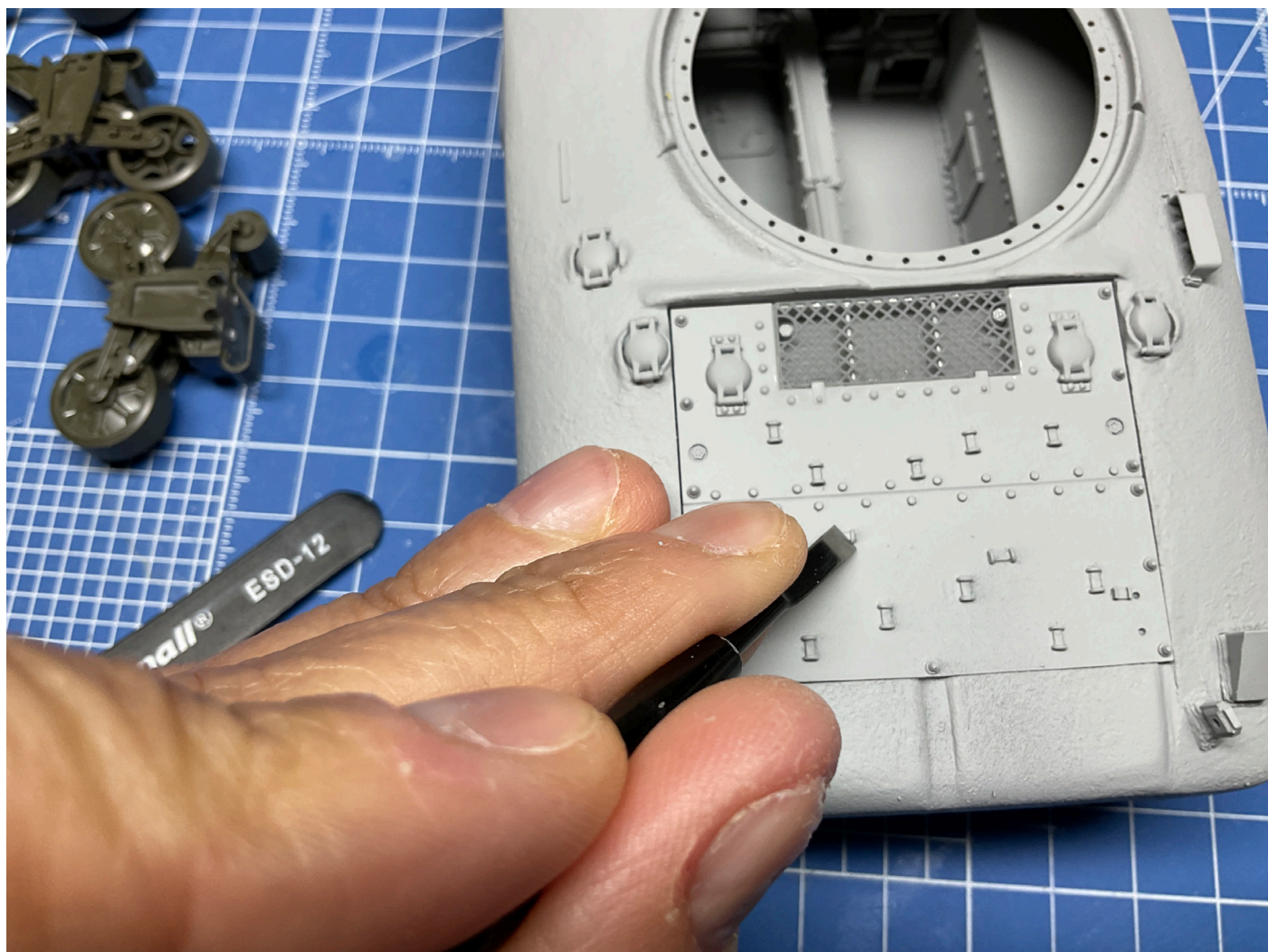

IF YOU WANT INSTALL ANY OVM TOOLS SHAVE OFF CORRESPONDENT LOOP THEN GLUE 3D PART OVER.

3DPARTS OPTIONS: THE TOOLS COULD BE WITH OR WITHOUT OVM INSTALLED

12) FRONT HULL

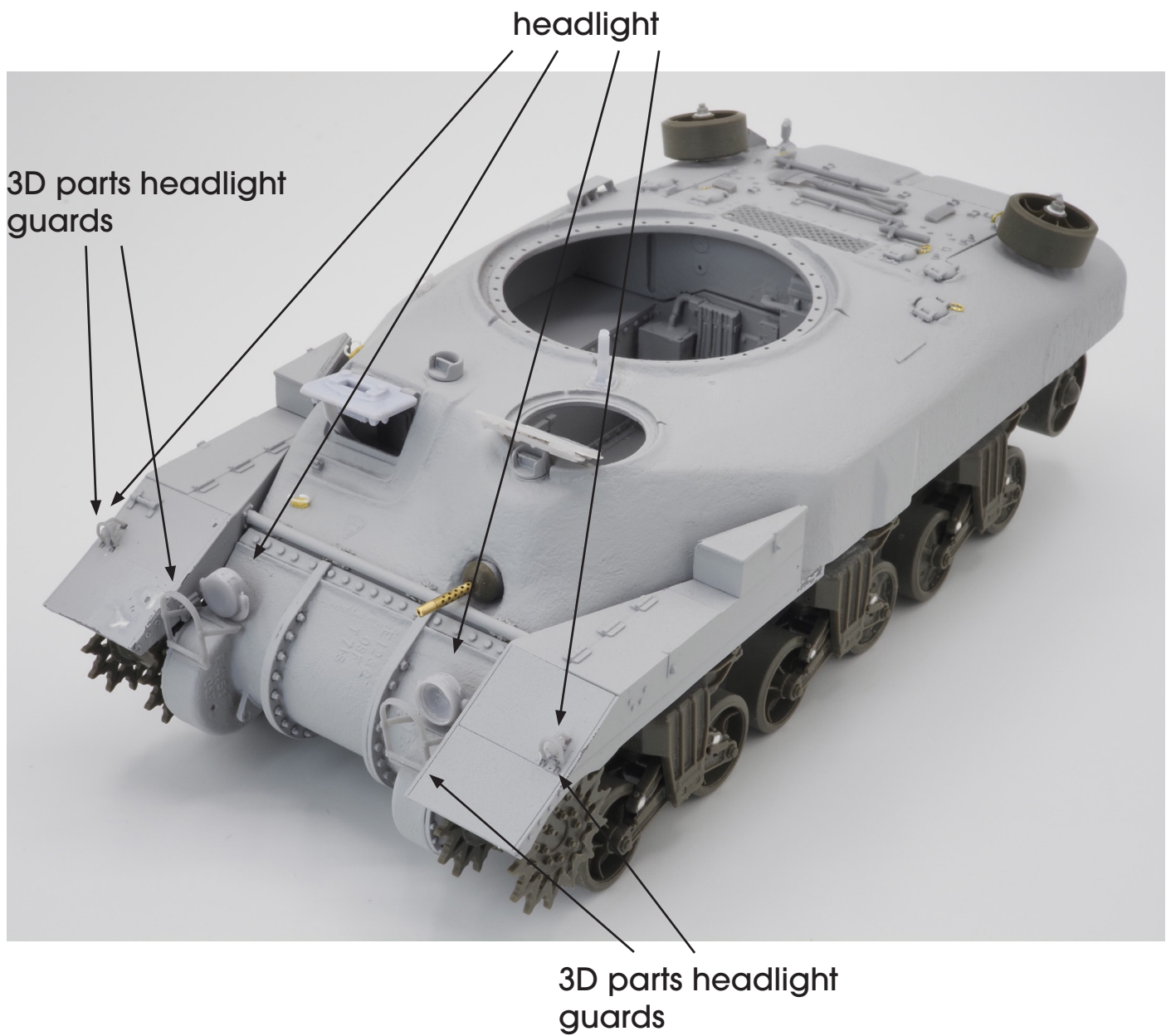







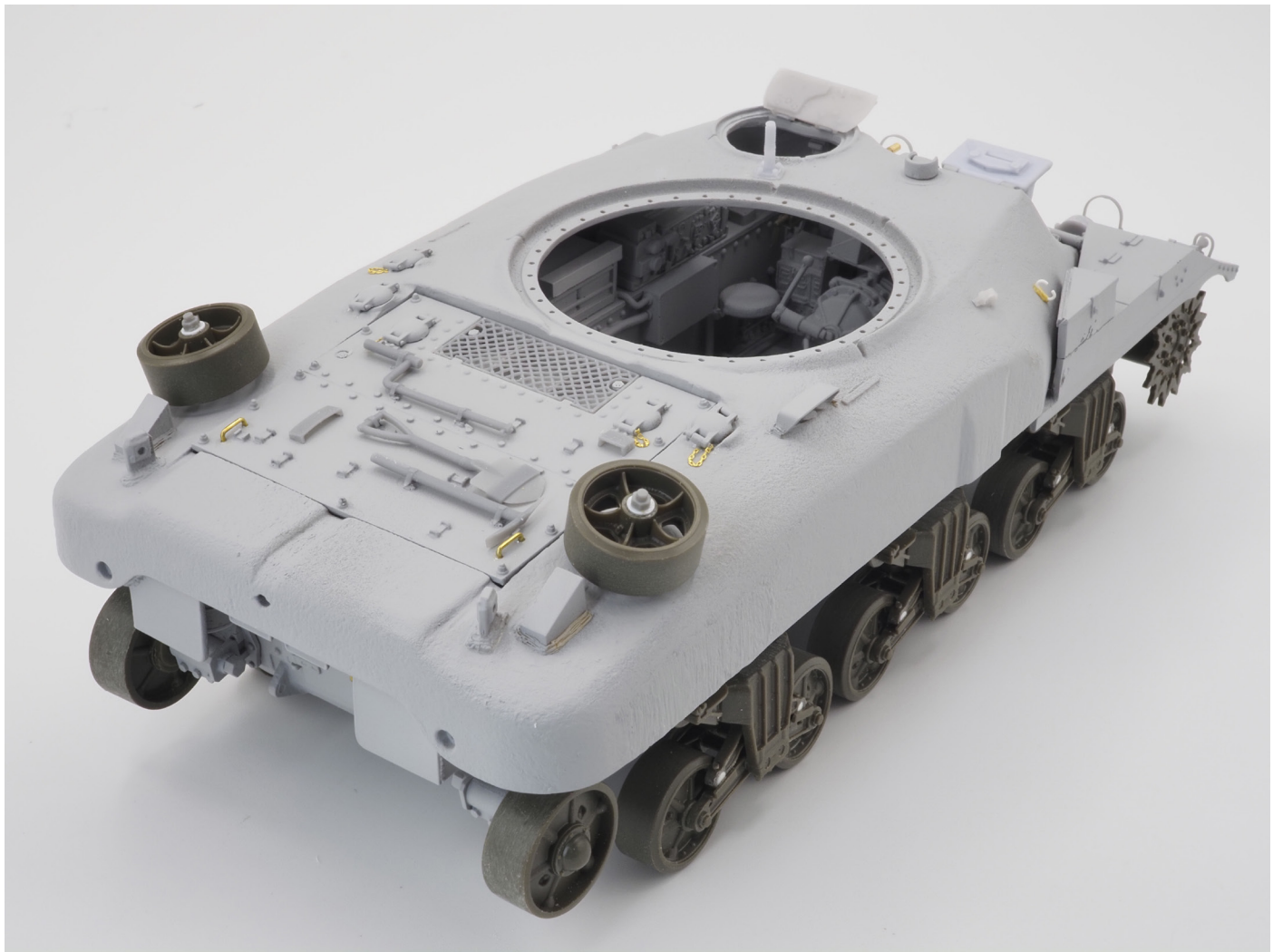



HDM35131 RAM Mk II late "Kangaroo" 1/35

Artwork created by Bill Miller, 1st Canadian Armoured Carrier Regiment Archive. Calgary, AB Canada. telephone 403-605-0059 email: info@canadiakangaroos.ca

157

157

157



BUTCH

BUTCH

CT-15 9891

CT-160098

CT16 0122

MARION FAME

MARION FAME

